

PGL-415DI-RZR1 | PGL-430DI-RZR1

(2 & 4 Seater) Polaris Razor 1000 XP 4" Dual Idler Portal Kit



Parts Available For These Popular Brands and Others

POLARIS

can-am



Kawasaki



HIGHLIFTER



sales@highlifter.com



800-699-0947 | 8:00am - 6:00pm CST



780 Professional Drive North, Shreveport, LA 71105



www.highlifter.com

PRODUCT DISCLAIMER

IMPORTANT PRODUCT USE AND SAFETY INFORMATION / WARNINGS

This product is designed for use on ATVs and/or RUVs to lower the final drive gear ratio and increase ground clearance. Purchasers should be aware that use of this product may increase the frequency of required maintenance, part wear, and will raise the center of gravity on your ATV and/or RUV, increasing risk of roll-over, injury and death on all types of terrain. It is your responsibility to always inform other operators and passengers of this vehicle about the added risks with this product.

High Lifter's products are designed to best fit user's ATV/RUV under stock conditions. Adding, modifying, or fabricating any OEM or aftermarket parts will void warranty. High Lifter Products, products could interfere with other aftermarket accessories. If the user has aftermarket products on machine, contact High Lifter Products to verify that they will work together. Adding aftermarket suspension components and/or more aggressive tires can cause breakage of other OEM driveline components such as differentials, axles or drive shafts.

Riders should be advised that the handling characteristics of a taller ATV and/or RUV are different and require extra care when riding, particularly on the side of hills or off-camber situations. If you further raise the center of gravity by adding taller tires, heavy loads to racks or seats, or by any other means, the ATV and/or RUV must be operated with even more care, at slower speeds and on relatively flat ground. All turns should be done at a slow speed, even on level ground.

Operation of an ATV and/or RUV with or without modified suspension components, while or shortly after consuming alcohol or drugs, subjects the rider and passengers to the risk of serious bodily harm or possible death. This risk is compounded if the riders do not wear an approved helmets and other safety gear. High Lifter urges that all approved safety gear be worn when riding an ATV and/or RUV as a driver or passenger.

By purchasing and installing High Lifter Products, products, user agrees that should damages occur, High Lifter Products will not be held responsible for loss of time, use, labor fees, replacement parts, or freight charges. High Lifter Products will not be held responsible for any direct, indirect, incidental, special, or consequential damages that result from any product purchased from High Lifter Products. The total liability of seller to user for all damages, losses, and causes of action, shall not exceed the total purchase price paid for the product that gives rise to the claim.

Dealers and other Installers

You are responsible for informing your customer and end user of the information contained above and the increased potential hazards of operating an ATV and/or RUV equipped with modified suspension components. If you install any suspension modifying components, it is your responsibility to also install the warning label prominently in view of the driver and in prominent view of the driver and passenger on RUVs and multi-passenger ATVs. They should also be instructed to notify anyone operating the vehicle, as well as any passengers, that said vehicle is modified.

As discussed above, it is critically important that they be instructed in the need for slower speed operation, regardless of terrain, after this lift kit is installed.

High Lifter Products, Inc., 780 Professional Dr N, Shreveport, LA 71105 - Phone: 1-800-699-0947

PRODUCT DISCLAIMER

THE PRODUCT IS/WILL:

- Designed and intended for use on a UTV at slow speeds.
- Increase the center of gravity.
- Increase the turning radius.
- Increase the stopping distance when adding larger tires.
- Increase and accelerate wear of factory components including bushings, bearings, ball joints, and tie rod ends.
- We cannot guarantee fitment with other aftermarket accessories.

Safety Guidelines:

- Inspect all moving factory suspension components particularly ball joints, tie rod ends, control arm connections, and brakes prior to each ride and replace if worn.
- Inspect clearances with control arms and brake lines prior to each ride.
- Wheel spacers should not be used with a Portal Gear Kit.
- 14" or larger wheels must be used with the Portal Gear Kit. 12" wheels cannot be used.
- Jumping, high speeds, and quick maneuvering should be avoided.

Maintenance Information:

- Check gear oil in portal boxes following 25 hours of riding or sooner, depending on how you ride.
- Use 4 oz of SAE 80W-90 Gear Lubricant as needed in each portal box.
- Replace worn factory components including bushings, bearings, ball joints, brakes, and tie rod ends when they show wear.

Any vehicle equipped with a Portal Gear Kit must have the enclosed large format "Warning to Driver" decal installed on the inside of the windshield or on the vehicle's dash, within driver's view. The "Warning to Driver" decal is to act as a constant safety reminder for whoever may be operating the vehicle.

INSTALLING dealer:

It is your responsibility to install the "Warning to Driver" decal and forward these installation instructions to the vehicle owner for review of warnings, product use, and maintenance information. Replacement Warning Decals are available FREE on request. These instructions are to be kept with the vehicle registration papers and owner's manual for the service life of the vehicle.

REFUSED Shipments/Order CANCELLATION:

Refused shipments are subject to a 20% restocking fee plus all associated freight costs. It is our goal to ship all orders in a timely manner. If a customer wishes to cancel an order (provided it is not a special order product), it is the responsibility of the customer to cancel the order prior to the product being shipped. If a customer cancels an order after product has been shipped, refused shipment, cancellation, or return will be subject to a 20% restocking fee and any freight charges incurred. For orders outside the United States, any fees associated with customs or duties are non-refundable.

DAMAGED Shipments:

All claims for damaged shipments must be made within 72 hours of delivery to the point of destination. Any damage to package should be noted with carrier at the time of delivery if possible. We will not be responsible for damage claims made over 72 hours after delivery to the point of destination.

PORTAL INTRODUCTION

READ THESE INSTRUCTIONS CAREFULLY. IT IS RECOMMENDED THAT A PROFESSIONAL MECHANIC PERFORM THE INSTALLATION. CARE SHOULD BE TAKEN TO FOLLOW ALL STANDARD SAFETY PROCEDURES.

- **PRIOR** to installation, a thorough inspection of the suspension should be made. Inspect the vehicles steering, driveline, and brake systems, paying close attention to the suspension link arms and bushings, anti-sway bars and bushings, tie rod ends, ball joints and wheel bearings.
- Also check the steering sector-to-frame and all suspension-to-frame attaching points for stress cracks. The overall vehicle must be in excellent working condition. Any worn, bent or broken parts should be repaired and/or replaced.

NOTE: DO NOT add or fabricate any components to gain additional suspension height.

NOTE: AFTER installation, another inspection should take place, checking for loose components or missing hardware. Inspect, again after eight (8) hours of operation. Remember to check your lug nuts again.

NOTE: A factory service manual should be on hand for reference. The manual will contain fastener torque specs, assembly techniques, and special tool requirements that are unique to this

REQUIREMENTS



TOOLS

- Jack & Stand
- Metric & standard socket assortments
- Metric & standard hex key/sockets
- Torque wrench
- Multi-purpose pliers
- Wire cutter/snips
- Mallet (Soft face hammer)
- Drift punch/pin
- Vice or Press



SUPPLIES

- Water-resistant grease
- DOT 4 brake fluid
- 80w90 gear oil



TIRE REQUIREMENTS

- Up to 30" Stock
- 31" with 3" Lift Kit
- 32" to 33" Forward Kit 1.5"
- 34" Forward Kit and Lift Kit
- 35" to 37" Big Lift Kit (45%)
- 38" to 39" Big Lift Kit (45% or 60%)
- 40" and UP Big Lift Kit (**STRONGLY SUGGEST 60%**)



WHEEL REQUIREMENTS

- 18" or larger wheel required
- 18" wheels cannot exceed 4-1/2" backspacing
- 20" and larger wheels cannot exceed 5" backspacing

HIGHLIFTER

PARTS DIAGRAM

HARDWARE, BRAKE LINE (PGLBOX-P403-DI-B1)

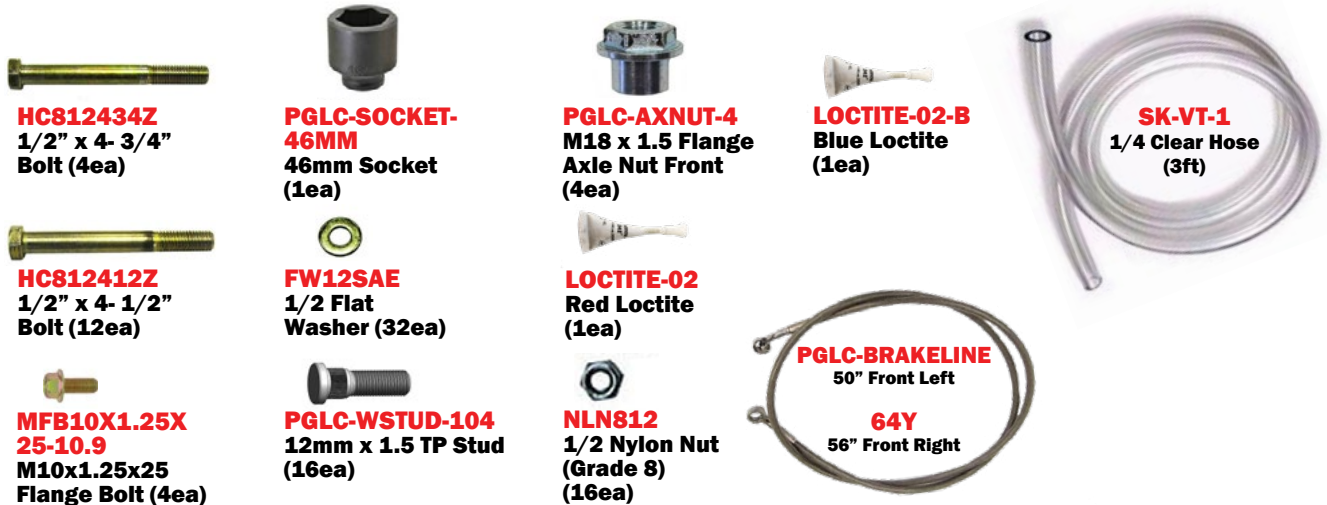

HUB & ROTOR (PLGBOX-HRB-401)

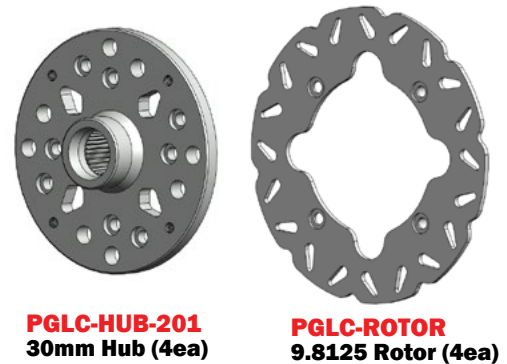

FRONT BACKING PLATES (PGLBOX-P403-DI-B2)

PORTALS

REAR BACKING PLATES (PGLBOX-P403-DI-B3)

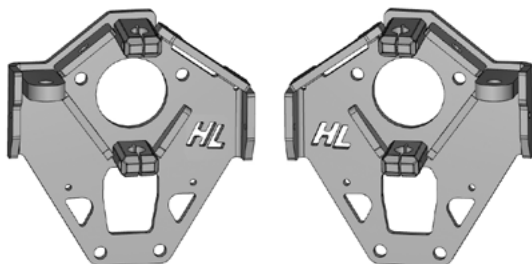

Portal Assembly (4ea)

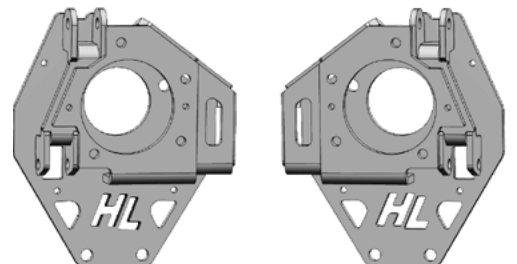
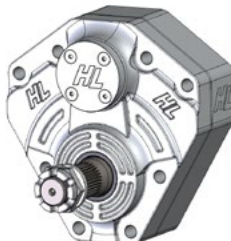

PART NUMBER	DISCRIPTION	QTY
MCS12X65-10.9	12mm X 65mm Bolt	4ea
MFW12	12mm Flat Washer	8ea
MLN12-1.75	12mm-1.75 Lock Nut	4ea
MCS10X1.25X35-10.9	10mmX1.25 X 35 Bolt	8ea
MFW10	10mm Flat Washer	16ea
MLN10-1.25	10mm-1.25 Lock Nut	8ea

Front INSTALL

FRONT WHEELS

Removal

1



FRONT PASSENGER SIDE KEEP ALL FACTORY HARDWARE.

Place jack under the **FRONT** center of the UTV and lift until the weight is off the suspension. Ensure that the vehicle is properly secured.

Raise unit an additional 4" to accommodate portals.

Remove the front wheels.

BRAKE CALIPER & BRAKE LINES

Removal

2



Remove the brake caliper mounting bolts (15mm). Remove the front mud scraper (8mm). **KEEP ALL FACTORY HARDWARE. DO NOT REMOVE BRAKE LINE.** Set caliper aside.

HUB ASSEMBLY

Removal

3

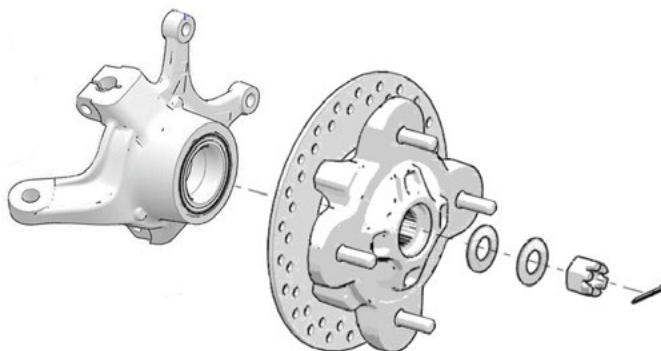

Remove the cotter pin, axle nut, and washers from the hub assembly, then remove the hub. (27mm)

6

REPEAT STEPS ON OPPOSITE SIDE

Front INSTALL

BALL JOINTS & TIE RODS

Removal

4

TIE ROD END



Disconnect the tie rod from the knuckle. (18mm)

KEEP ALL FACTORY HARDWARE.

UPPER BALL JOINT



Disconnect the Upper ball joint by removing the bolt at the knuckle. (15mm)

LOWER BALL JOINT



Disconnect the Lower ball joint by removing the bolt at the knuckle. (15mm)

FRONT BACKING PLATE

Install

5

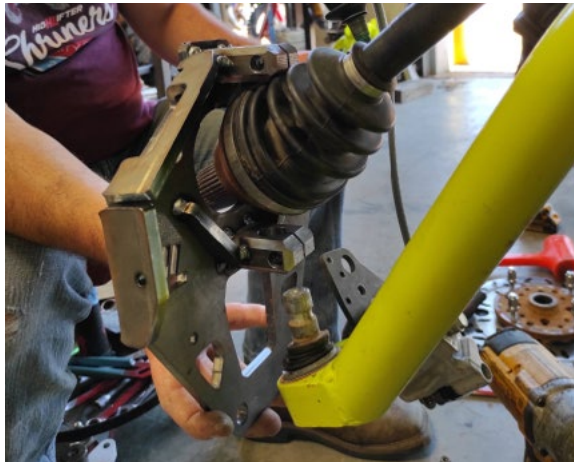

Insert the lower ball joint into the lower mount bracket on the backing plate.

Insert the axle into the backing plate.

Insert the upper ball joint into the upper mount bracket.

Fasten ball joints with the factory hardware. (15mm) [50 ft lbs]

Note: You may need to clean powder coating from the holes.

BOX CAP

Install

6



Remove the 1/4-20 x 3/4" screws & cap/gasket from the lid of the portal box.



CORRECT ✓

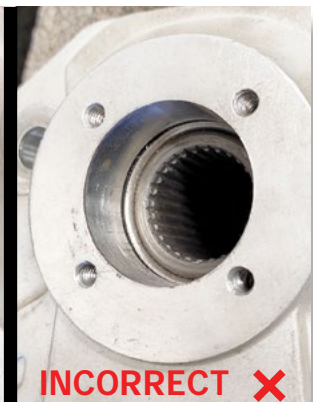

INCORRECT ✗

NOTE: On the FRONT & REAR portal boxes, the drive gear splines should be recessed to accommodate the shorter front drive shaft splines.

REPEAT STEPS ON OPPOSITE SIDE

Front INSTALL

FRONT CALIPER BRACKET

Install

7

REAR

Each side has pre-installed hardware on the portal box.

The installment should look like the featured diagram, when complete.

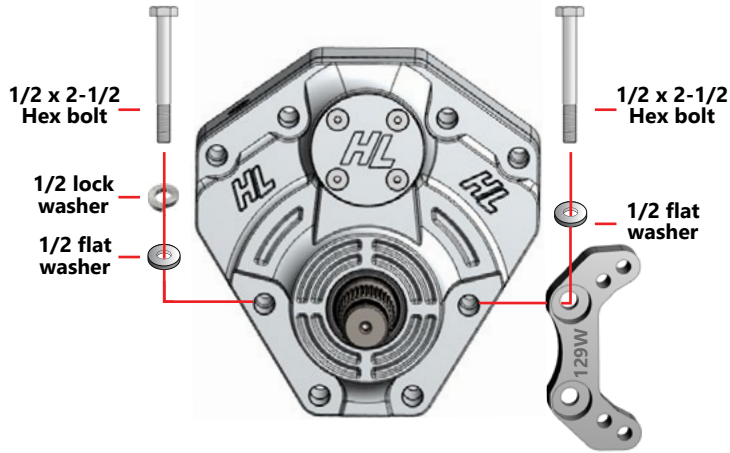

FRONT

Install the **129W** caliper bracket facing the **FRONT** of the vehicle.

YOU MUST DISCARD THE PRE-INSTALLED LOCK WASHER ON THE BRACKET SIDE.

The bolt head should sit flush with the bracket.

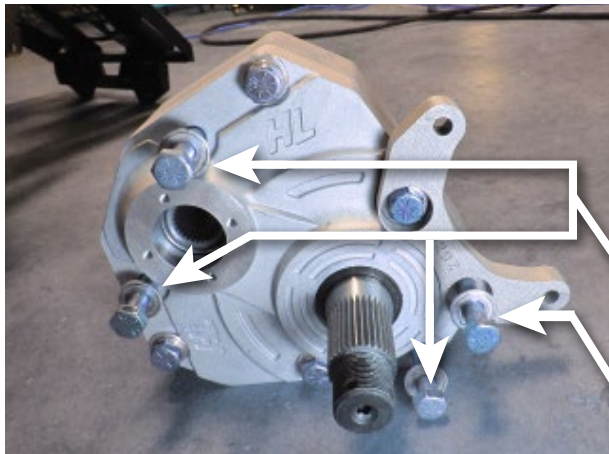

Insert the washers and bolts below through the remaining (4) holes in the front portal box.

**1/2 Flat Washer
1/2 x 4-1/2" Bolt**

**1/2 Flat Washer
1/2 x 4-3/4" Bolt**

FRONT PORTAL

Install

8



Apply water-resistant grease to the drive splines. Be sure to apply product all around the outer edge as well.

Rotate the portal box 'Up & In' as you guide the drive shaft axle through the inner drive gear. Loosely fasten all four bolts with 1/2" flat washers and 1/2" lock nuts. Ensure parts fit correctly then torque. (3/4) [105 ft lbs]

Insert the bolts through the corresponding holes in the backing plate.

Front INSTALL

FRONT PORTAL

Install

9



Loosely fasten all (4) bolts with 1/2" flat washers and 1/2" lock nuts. Ensure parts fit correctly then torque. (3/4) [105 ft lbs]

TIE ROD

Install

10



TIE ROD END

Install the tie rod end into the backing plate mount bracket. Fasten with the factory hardware. (18mm) [90 ft lbs]

NOTE: If you are using our High Lifter Big Lift or Front Forward Arms in conjunction with this portal kit, you may need to drill out the tie rod mount bracket to utilize the steering hardware you are currently using.

FRONT PORTAL

Install

11

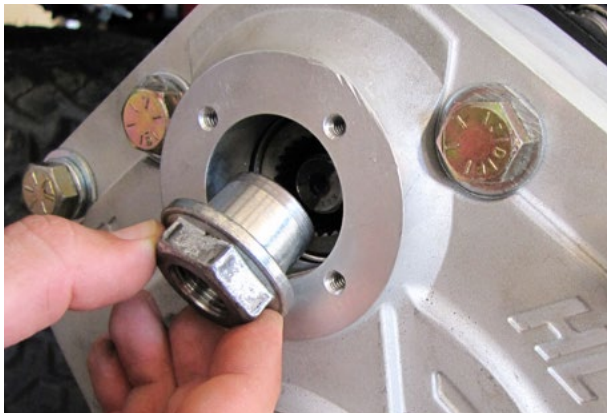

Apply LOCTITE (BLUE) to the supplied M18 axle nut with shoulder PGLC-AXNUT-4 and torque onto the drive shaft axle. (30mm) [20 ft lbs]

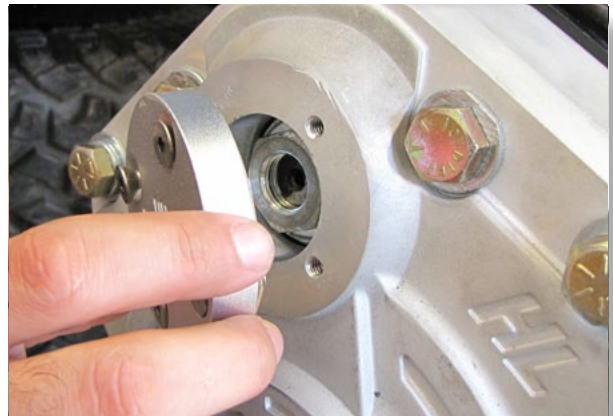

Align the portal box lid cap & gasket. Use the 1/4-20 x 3/4" screws and install the cap to the portal box. [8 ft lbs]

REPEAT STEPS ON OPPOSITE SIDE

Front INSTALL

ROTOR ASSEMBLY

Install

12

Locate all (4) multi pattern hubs, so they can all be assembled at the same time. They are designed to work with different bolt patterns.

NOTE: They may have oil on them to prevent corrosion. If so, you will need to use a cleaner and remove most of the oil.

With the shorter lip side faced down, find the bolt pattern that corresponds to your make and model. Use the provided studs (12mm-1.5 stud) (4/156mm bolt pattern)

156mm

137mm

110mm
.....

Tapped holes for rotors

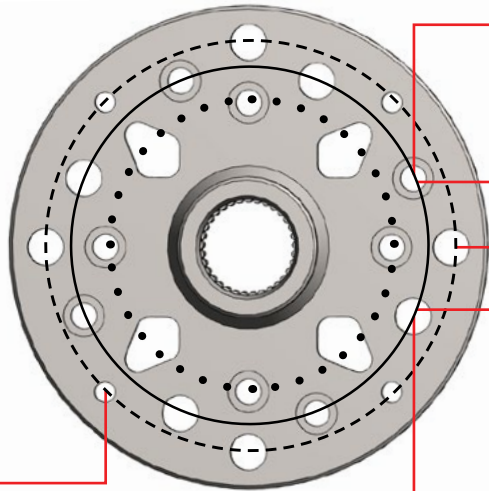

3/8-24 Stud



10mm-1.25 Stud



12mm-1.5 Stud *



12mm-1.25 Stud

ROTOR ASSEMBLY

Install

13

For the following steps, place this side (the shorter lip) face down on your working surface.

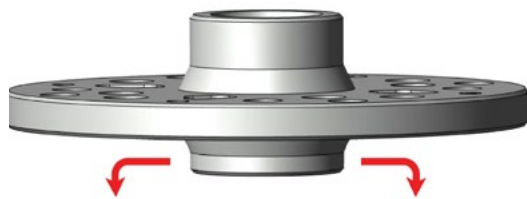

This side will face away from the UTV when installed.

14



DO NOT PRESS THE STUDS INTO THE TAPPED HOLES THAT ARE FOR THE ROTOR.

Press in stud with vice or press

12mm -1.5 Stud

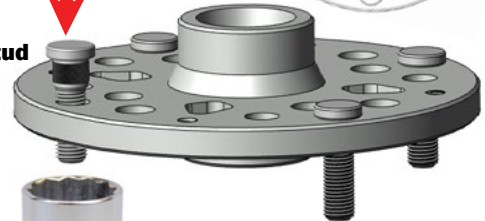

Use a socket or something similar to back the stud and rotor.

Front INSTALL

ROTOR ASSEMBLY

Install

15

Place the 1/2 spacers over the tapped holes. These spacers go **BETWEEN** the hub and rotor.

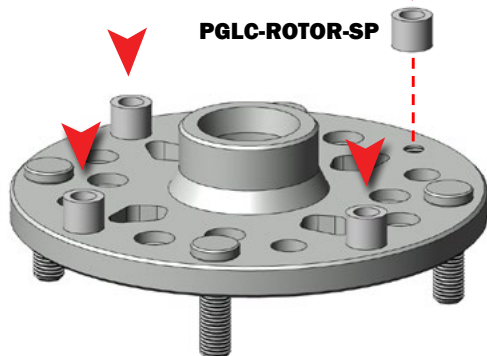

16

NOTE: COUNTER BORES ON ROTOR SHOULD BE FACING UP.

Install the rotor and secure it to the hub by applying **LOCTITE (RED)** to the (4) 3/8-16 x 1" button head bolts. (7/32) [45 ft lbs]

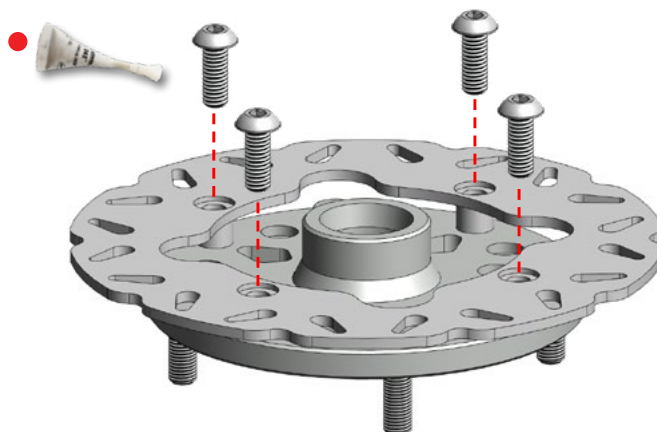

ROTOR ASSEMBLY

Install

17

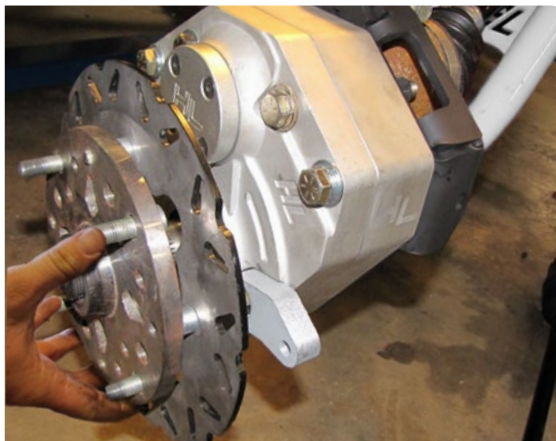

Apply waterproof grease to the spindle splines and slide the brake rotor onto the spindle shaft.

18



Slide on the 30mm lock washer, 30mm castle nut. (46mm) [Min 120 ft lbs]

Tighten the castle nut further if needed to align grooves with hole in the spindle for the cotter pin.

Install the cotter pin, then bend it to secure it.

FRONT BRAKE LINES

Removal

19



Disconnect the stock brake line from the caliper, if you have not done so already.

REPEAT STEP ON OPPOSITE SIDE

20 LEFT DRIVER SIDE (PA) = Passenger Side (DR) = Driver Side

Disconnect the factory brake lines from any retaining clips or ties that are still holding them in place.



Locate the master cylinder on the (DR) side.



Unplug the connector.



Disconnect the banjo bolt and brake lines from the master cylinder.

Have a container ready to collect brake fluid.



Save the factory washers that separate the two front lines. Remove the line from the UTV.

21 RIGHT PASSENGER SIDE



Install the (64Y) 56" FRONT RIGHT brake line to the banjo bolt. Run the line back through the frame and to the RIGHT (PA) side hub.

LEFT DRIVER SIDE



Install the new (PGLC-BRAKELINE) 50" FRONT LEFT brake line to the banjo bolt. Run the line back through the frame and to the LEFT (DR) side hub.

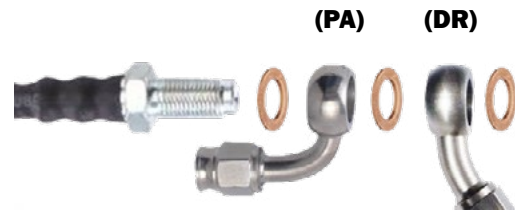

The factory brake line banjo bolt should be in this sequence: bolt, washer (PA) brake line, washer (DR) brake line, and washer.



Fasten banjo bolt to master cylinder. Torque (12mm) [50 ft lbs]

Re-secure the connector

22



UPPER CONTROL ARM

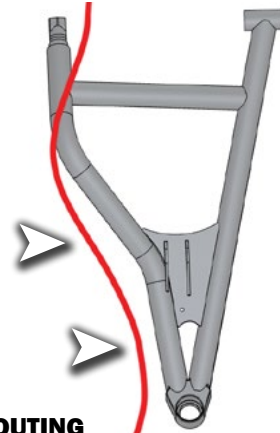

BRAKE LINE ROUTING

Route the brake line through the **FRONT UPPER ARM**. Position the banjo fitting to the proper angle for maximum suspension travel. Secure the line to the arm using the **factory clamps** or the supplied zip ties.

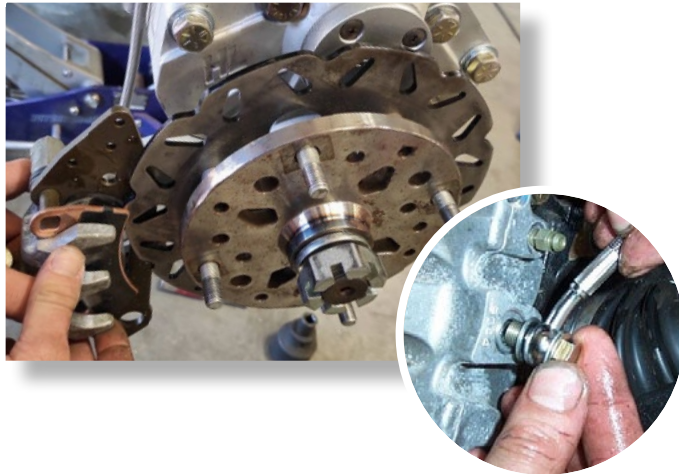

CALIPER

Install the caliper onto the portal box and secure it with the factory caliper bolts. Install the brake line banjo fitting onto the caliper being careful not to allow debris to enter the caliper. **Ensure there is a washer on EACH side of the banjo fitting.** **NOTE:** Remember, the bleed off valve always goes to the **TOP** of the caliper. torque (13mm) [15 ft lbs]



BACKING PLATE

Secure the brake line to the **FRONT** of the portal backing plate by using a p-clamp. Insert a 5mm x 20mm bolt through the clamp and backing plate, followed by a 5mm washer and 5mm lock nut.

Rear INSTALL

REAR WHEELS

Removal

23



REAR PASSENGER SIDE

KEEP ALL FACTORY HARDWARE.

Place jack under the **REAR** center of the UTV and lift until the weight is off the suspension. Ensure that the vehicle is properly secured.

Raise unit an additional **4"** to accommodate portals.

Remove the rear wheels.

BRAKES & HUB

Removal

24

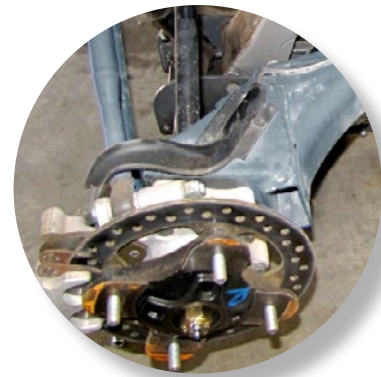

Discard the brake line guide. **KEEP FACTORY HARDWARE.**



Remove the brake caliper mounting bolts from the hub assembly (15mm). Set Brake caliper aside.

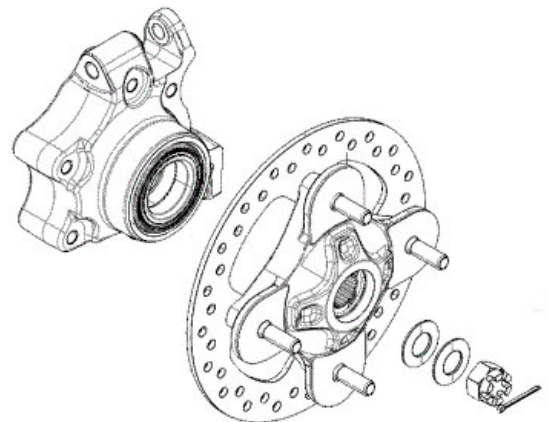

Remove the cotter pin and castle nut (27mm) on the rear axles, then remove the brake rotor assembly.

REPEAT STEPS ON OPPOSITE SIDE

Rear INSTALL

BRAKES & HUB

Removal

25

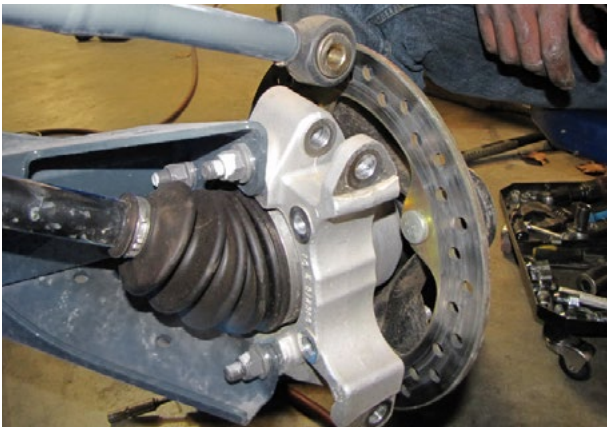

Remove the bolts and nuts that attach the rear knuckle to the UPPER & LOWER RADIUS BARS (15mm).

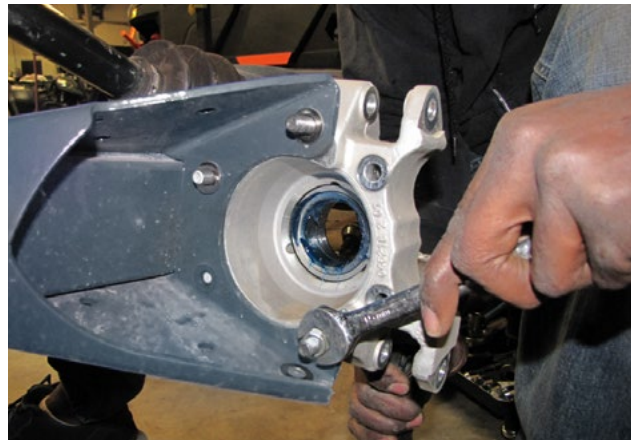

Remove the bolts and nuts that secure rear knuckle to the TRAILING ARM (15mm) Remove the rear knuckle.

REAR BACKING PLATE

Install

26

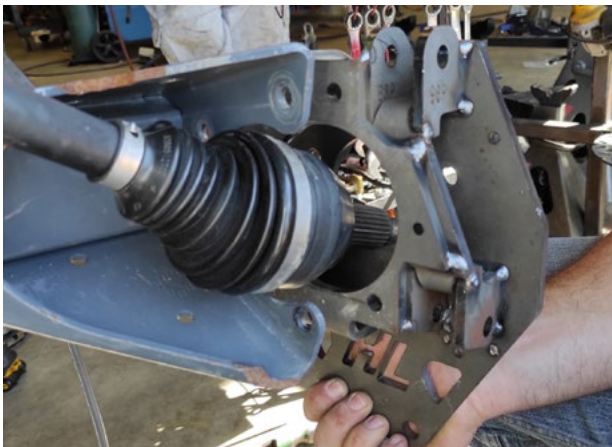

Place the backing plate into position on the trailing arm and guide the drive shaft through.

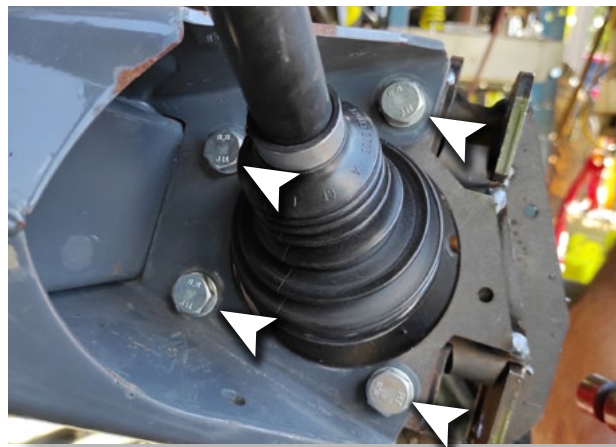

Install the backing plate to the trailing arm using M10-1.25x35 bolts and 10mm flat washer on each side. Then fasten bolts with M10-1.25 lock nuts. (15mm) [56 ft lbs]

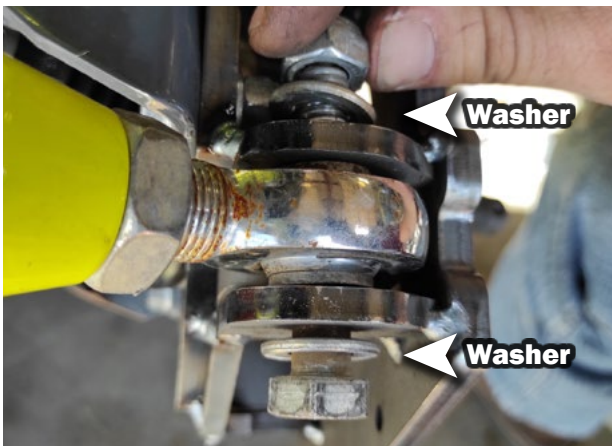

Use a 12mmx 65 bolt to secure the upper and lower radius bar. Install (2) 12mm washers on each side and secure it with a 12mm lock nut. (18mm) [90 ft lbs]



Rear INSTALL

BOX CAP

Install

27

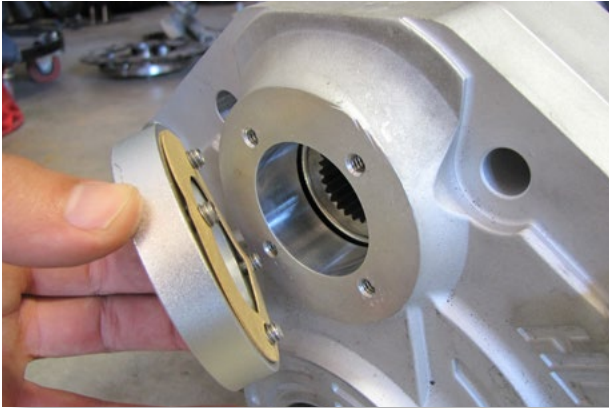

Remove the 1/4-20 x 3/4" screws, cap, and gasket from the lid of the assembled portal box.

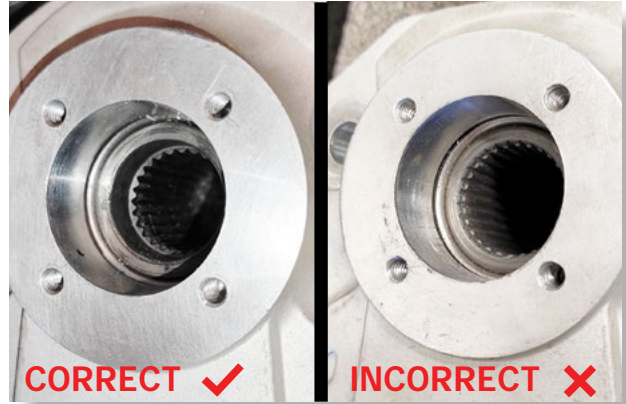

NOTE: On the FRONT & REAR portal boxes, the drive gear splines should be recessed to accommodate the longer rear drive shaft splines.

REAR CALIPER BRACKET

Install

28

REAR

Each side has pre-installed hardware on the portal box.

The installment should look like the featured diagram, when complete.

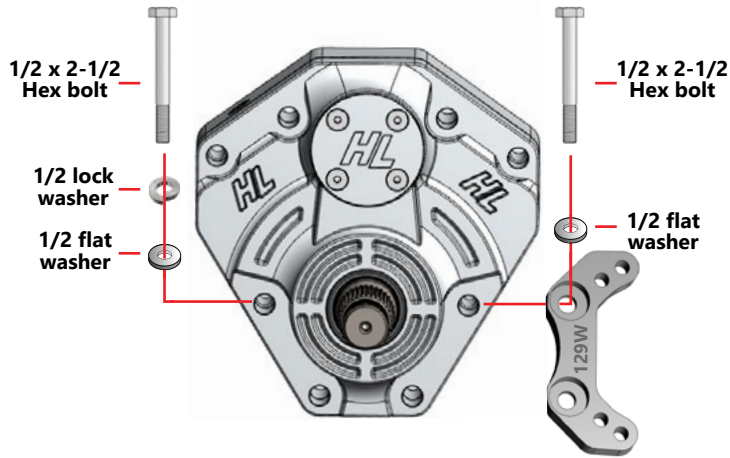

FRONT

Install the 129W caliper bracket facing the FRONT of the vehicle.

YOU MUST REMOVE THE PRE-INSTALLED LOCK WASHER.

29

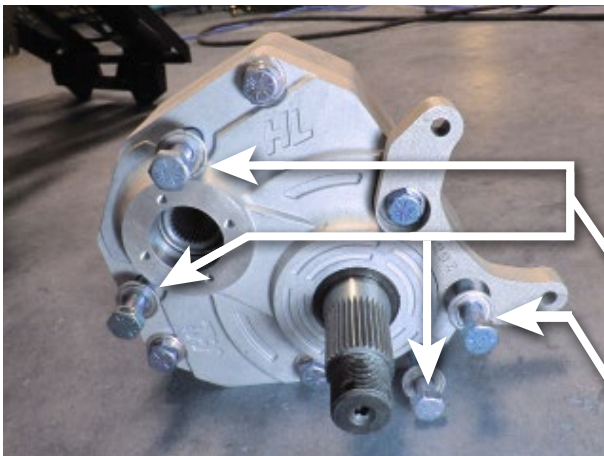

Insert the washers and bolts below through the remaining (4) holes in the front portal box.

**1/2 Flat Washer
1/2 x 4-1/2" Bolt**

**1/2 Flat Washer
1/2 x 4-3/4" Bolt**

REPEAT STEPS ON OPPOSITE SIDE

Rear INSTALL

REAR PORTAL

Install

30

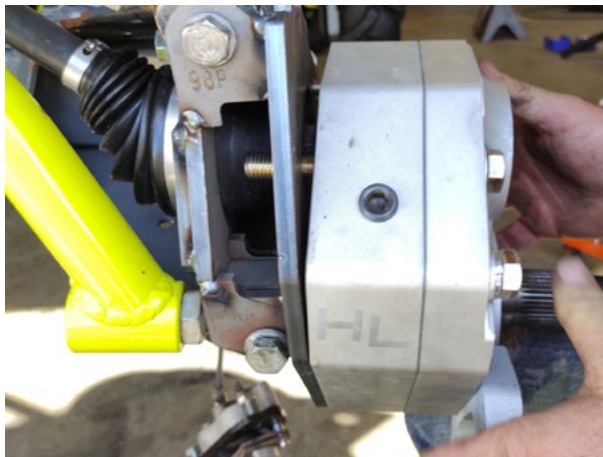

Apply water-resistant grease to the drive splines. Be sure to apply product all around the outer edge as well.

Rotate the portal box 'Up & In' as you guide the drive shaft axle through the inner drive gear.

Insert the bolts through the corresponding holes in the backing plate.



Loosely fasten all (4) bolts with 1/2" flat washers and 1/2" lock nuts. Ensure parts fit correctly then torque. (3/4) [105 ft lbs]

REAR AXLE NUT

Install

31



With the portal box installed, apply LOCTITE (BLUE) to the supplied M18 axle nut PGLC-AXNUT-4 and torque onto the drive shaft axle. (30mm) [20 ft lbs]

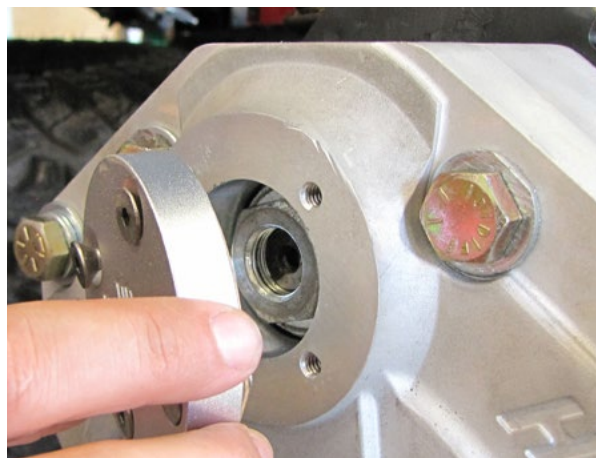

Align the portal box lid cap & gasket. Use the 1/4-20 x 3/4" screws and install the cap to the portal box. [8 ft lbs]

Rear INSTALL

ROTOR ASSEMBLY

Install

32

IF YOU HAVE NOT ALREADY ASSEMBLED THE HUB TO THE ROTOR, REFER TO STEPS 12-16 FOR DETAILS.

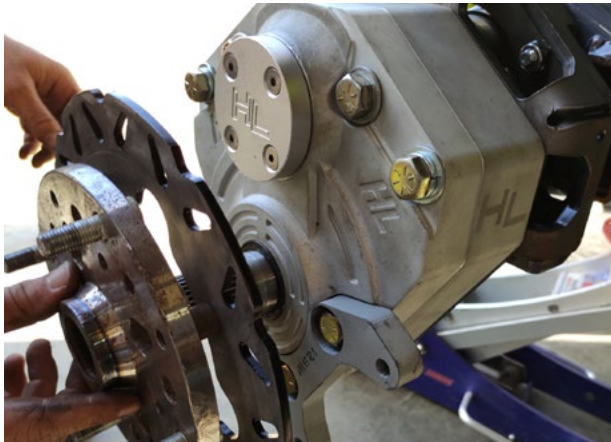

Apply waterproof grease to the spindle splines and slide the brake rotor assembly onto the spindle shaft.



Slide on the 30mm lock washer, 30mm castle nut. (46mm) [Min 120 ft lbs] Tighten the castle nut further if needed to align grooves with hole in the spindle for the cotter pin. Install the cotter pin, then bend it to secure it.

BRAKE CALIPER

Install

33

BECAUSE THE BRAKE CALIPER BRACKET HAS BEEN RELOCATED TO THE FRONT OF THE PORTAL BOX...

THE ORIGINAL (DR) SIDE BRAKE CALIPER WILL BE USED ON THE (PA) SIDE.
THE ORIGINAL (PA) SIDE BRAKE CALIPER WILL BE USED ON THE (DR) SIDE.



Disconnect the rear factory brake lines from the calipers. Have a container ready to collect brake fluid.



Remove the stock hanger bracket. Install the 85X hanger bracket into the brake caliper.



85X



Reconnect the line and Install the caliper onto the portal box. Use the supplied M10X1.25x 25 flange bolt to secure the caliper to the bracket [30 ft lbs]. (These replace the factory 50mm bolts)

NOTE: Remember, the bleed off valve always goes to the TOP of the caliper. torque [15 ft lbs]

REPEAT STEPS ON OPPOSITE SIDE

34

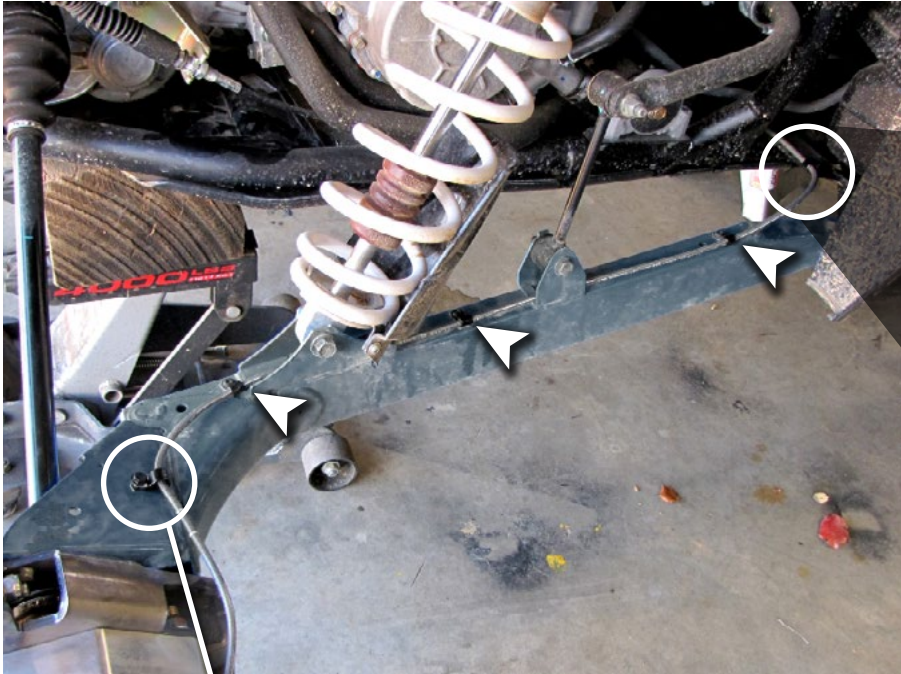

TRAILING ARM

Flip p-clamp around to gain more slack.



Before securing the brake line, make sure you have enough slack to reach your brake caliper without any binding. You may need to pull some extra slack out of the line if needed.

Attach the unsecured brake line slack to the trailing arm. Discard brake line guide. Use the provided ½" loom clamp WL-CLAMP-12, then reuse the factory hardware from the brake line guide to reattach to the trailing arm.

35



BACKING PLATE

Install the 5x20 bolt and 5mm washer to the **FRONT** of the backing plate. Secure it with the 5mm x .80 lock nut.



You can install the p-clamp in either location on the front of the portal backing plate.

NOTE: ENSURE THAT THERE IS NO BINDING, PINCHING, OR INTERFERENCE WITH MOVING PARTS AND THE NEW BRAKE LINES.

36

NOTE: USE DOT 4 BRAKE FLUID

CAUTION: ALWAYS wear eye protection like safety glasses. Brake fluid will damage finished surfaces. Do not allow brake fluid to come in contact with finished surfaces.

1. Bleeding the brakes is a two person job; you will need someone at the brake caliper and someone to pump the brake foot pedal. Take precautions due to the vehicle being on jacks and/or jack stands.
2. Clean the master cylinder cover thoroughly and remove the cover.
3. With all bleeder screws open, a gravity bleed is recommended to start with. This will push all the air out at once and eliminate most of the air bubbles. (Have area prepared for spills and cleaning)
4. Add brake fluid to the indicated MAX level of the reservoir. (Any DOT 4 Brake Fluid)
5. Close off each line once you steadily see fluid coming out.
6. Begin final bleeding procedure with the caliper that is the farthest from the master cylinder. It should be this sequence - (PA) REAR, (DR) REAR, (PA) FRONT, and then (DR) FRONT.
7. You can use the supplied clear hose to attach to the caliper bleeder screw. Be sure the hose fits tightly on fitting. Now place the other end of the hose into a clean container.
8. Install a box end wrench on the caliper bleeder screw. Have your brake buddy slowly pump the foot pedal until pressure builds and holds. Have your buddy hold brake pedal down to maintain pedal pressure. Now slowly open the caliper bleeder screw 1/4" turn so the air and fluid will displace into the container.
9. Close bleeder screw, and then have your buddy release the foot pedal.
10. Repeat steps until clean fluid appears in the bleeder hose & all the air has been purged... Close bleeder screw, pump brakes, hold pressure, open bleeder, close bleeder, release foot pedal, check master cylinder.
11. Check the master cylinder fluid level. **NOTE: You must maintain at least 1/2" (1.27cm) of brake fluid in the reservoir to prevent air from entering the master cylinder.**
12. Tighten bleeder screw securely and remove bleeder hose. Torque the bleeder screw. [4 ft lbs]
13. REPEAT procedure steps for the other three (3) brake calipers in the sequence listed above.
14. Add brake fluid to MAX level inside master cylinder reservoir after the last caliper is completed. Install master cylinder reservoir cover. Check brake system for leaks.
15. Once completed, dispose of used fluid properly.

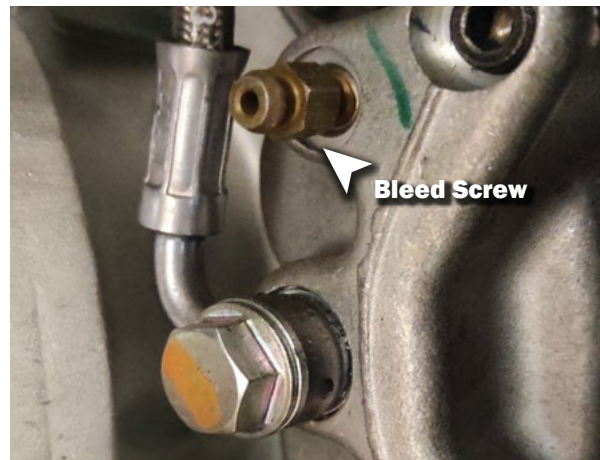

NOTE: Do not release foot pedal before the bleeder screw is tight or air may be drawn into the master cylinder... and you have to start all over again!

REPEAT STEPS ON OPPOSITE SIDE

37



DO NOT USE AN IMPACT TOOL ON ANY PLUGS.



ALL PLUGS MUST BE LUBRICATED OR WRAPPED IN TEFLON TAP. PLUGS MAY NOT SIT FLUSH. DO NOT TIGHTEN TO MORE THAN 10FT LBS OF TORQUE.

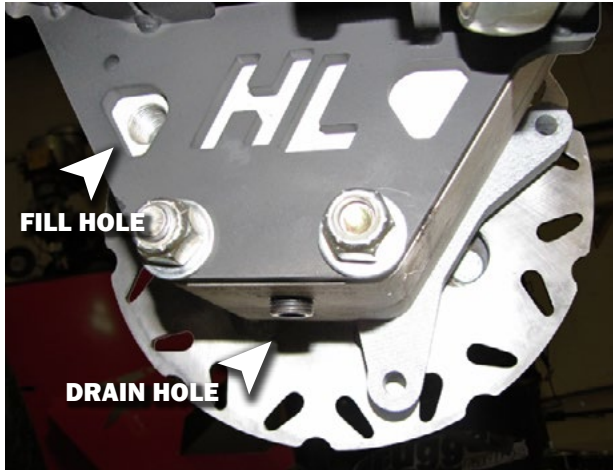

1. Ensure the vehicle is positioned securely and 'Level'.
2. On the bottom of the box is the drain hole and plug. Make sure the plug is wrapped in Teflon tape or lubricated with oil or grease. Tighten to [10 ft lbs] (8mm)
3. On the lower backside of the backing plate is an opening for the portal box fill hole and plug. Remove the fill plug. (8mm)
4. Place the gear oil bottle spout into the fill hole. You can gently 'Squeeze' the bottle to help the process.
5. Fill the portal box until the fluid starts draining back out of the fill hole. Then reinstall the fill plug, wrap the threads with Teflon tape or lubricate threads with oil or grease. [10 ft lbs] (8mm)



Use SAE 80W-90 oil. This gear lubricant is designed for gears operating under severe temperature and load conditions. SAE 80W-90 viscosity grade offers extended performance.

CAUTION: Do not over fill past the fill plug. If the oil heats up or expands, it will cause the oil to exhaust out the axle seal.

6. On the top of the box is the vent hole and plug. Using an Allen wrench, make sure the plug is tightened. [10 ft lbs] (8mm)

38

WHEEL INSTALL

Wheel Requirements:

- 18" or larger wheel required
- 18" wheels cannot exceed 4-1/2" backspacing
- 20" and larger wheels cannot exceed 5" backspacing

Tire Requirements:

- Up to 30" Stock
- 31" with 3" Lift Kit
- 32" to 33" Forward Kit 1.5"
- 34" Forward Kit and Lift Kit
- 35" to 37" Big Lift Kit (45%)
- 38" to 39" Big Lift Kit (45% or 60%)
- 40" and UP Big Lift Kit (STRONGLY SUGGEST 60%)

- Install wheel lug nuts and securely tighten.
- Remove all jacks, jack stands, and other devices used to lift and hold the vehicle.
- With the suspension supporting vehicle weight, torque the wheel lug nuts using an "X"tightening pattern.

Aluminum wheels = [90 ft lbs]

Steel wheels = [50 ft lbs]

WARNING: Re-tighten lug nuts at eight (8) hours after any wheel change or anytime wheel nuts are loosened. Failure to do so could cause wheels to come off while the vehicle is in motion. This is a warning and reminder.

REMEMBER: You just bled the brakes, unbolted and bolted steering and drive train components, added more take-off torque and made many changes by adding the portal boxes. **FIELD TEST** this machine at **LOW** speed before putting into full time Play or Work Mode. Check the brakes for proper braking action & pedal reserve.

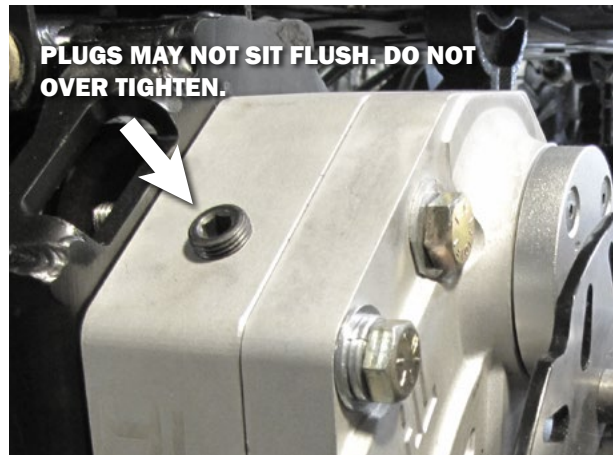

An optional vent line kit will be available in the future.

39

IF YOU HAVE ADJUSTABLE CONTROL ARMS, YOU MUST ADJUST THE CAMBER FIRST BEFORE PROCEEDING. DO NOT INSTALL WHEELS ONTO UTV UNTIL PROPER ALIGNMENT HAS BEEN ACHIEVED.

- Straighten steering wheel
- Make sure that the brake rotors are straight to sight or level.
- Take a tape measure and measure from inside to inside on the front and back ends of the rotors.

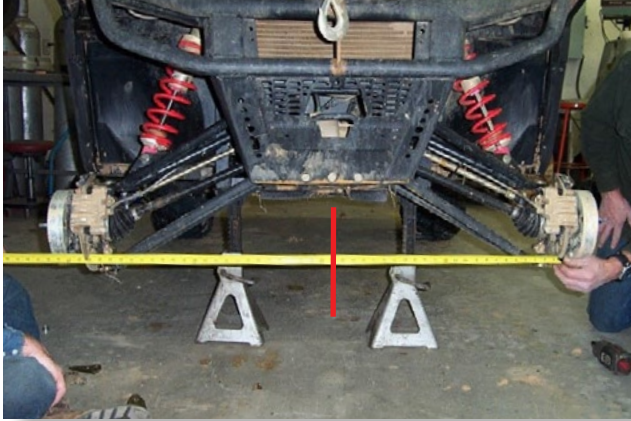

INCORRECT TOE

If the toe alignment is incorrect, measure the distance between vehicle center and each wheel. This will indicate which tie rod needs adjustment.

ADJUSTING TOE

- Adjust tie rods until **BOTH** measurements are the **SAME**, then adjust toe tolerance.

The recommended vehicle toe tolerance is 1/8" to 1/4" (3.175-6.35mm) toe out. This means the **FRONT MEASUREMENT IS WIDER THAN THE REAR MEASUREMENT.**

TOE ADJUSTMENT CHART

TOE (Inches)	1/16	1/8	3/16	1/4	5/16	3/8
TOE (Degrees)	0.12°	0.25°	0.38°	0.51°	0.64°	0.76°

Recommended Settings



If the **FRONT OF THE WHEELS** are facing **OUT**, adjust the tie rods **OUT** or **INCREASE the length of the tie rod.**

Measurement at the front of the tires will be **GREATER** than the rear, if the **TOE IS OUT.**



If the **FRONT OF THE WHEELS** are facing **IN**, adjust the tie rods **IN** or **REDUCE the length of the tie rod.**

Measurement at the front of the tires will be **LESS** than the rear, if the **TOE IS IN.**



IMPORTANT NOTE: When tightening the tie rod jam nuts, the tie rod ends must be held parallel to prevent rod end damage and premature wear. Damage may not be immediately apparent if done incorrectly.

After alignment is complete, tighten & torque tie rod end jam nuts to specifications. [12-14 ft lbs]

HIGHLIFTER



HIGH LIFTER LIMITED LIFETIME WARRANTY

High Lifter offers a Limited Lifetime Warranty to the original purchaser that our product shall be free from defects in material and workmanship for the life of the product if utilized in accordance with the manufacturer's instructions for installation and operation of said products.

LIMITED LIFETIME WARRANTY EXTENDS TO THE FOLLOWING PRODUCT LINES:

- **Lift Kits (Signature, Standard and Big Lifts)**
- **Control Arms**
- **Trailing Arms**
- **Radiator Relocation Kits**
- **Portal Gear Lifts**
- **Wheel Spacers**
- **Tow Hooks**
- **Control Arm Link Kits**

Damages to vehicle or any other object during the installation, use, or removal of High Lifter products are not covered under this warranty. Normal wear items included with any of the products covered under this Limited Lifetime Warranty are excluded from coverage. These items include, but are not limited to heim joints, tie rods, bearings, bushings, seals, gaskets, zinc plating, painted and powder coated finishes. Other exclusions of coverage under this warranty include, but are not limited to: damage or product failure due to improper installation, lack of maintenance, product modification, abuse, collision or use on vehicles for which product was not designed, repairs performed by anyone other than approved High Lifter personnel or made using non-High Lifter components. This warranty is valid for the original purchaser only and is non-transferable. High Lifter reserves the right to inspect any product before determining if the claim is valid and covered under this warranty. Claims determined to be caused by reasons other than a manufacturer defect will be rejected and an estimate for repair or cost of a replacement product if a repair is not possible, will be provided.

This warranty is exclusive and is in lieu of any implied warranty of merchantability, fitness for a particular purpose or other warranty of quality, whether express or implied, except the warranty of title.

WARRANTY PROCESSING

If you suspect your product is defective, **DO NOT** disassemble the product to determine the cause without prior approval as it may void your warranty status. This is especially true with our Portal Gear Lift. To begin the claim process, please e-mail our warranty team at warranty@highlifter.com and include the following in the e-mail:

- Your full name, address and contact phone number.
- The year, make and model of your vehicle
- The part number of the product
- Photos of the product installed, and vehicle product is installed on
- Proof of Purchase (Required for all warranty claims and you must be the original purchaser)

Once a claim is created, you will receive a return authorization number (RMA). Write this number on the outside of the box containing your defective product and include it along with your name and contact information inside the box. Product must be returned in the original box or a box of equal strength and packaging. Product sent without an RMA number visible on the outside of the box or sent COD will be refused. Ship your product to the following address:

High Lifter Products, Inc.
Attn: Returns 780 Professional Dr N Shreveport, LA 71105

Once your product is received, we often have your replacement or repaired product shipped back to you within 3-business days of receiving it. Please note that High Lifter is not responsible for shipping charges on product returned for warranty or repair, including duties and fees required by those residing outside the United States.

THANK YOU FOR CHOOSING
HIGHLIFTER

HIGH LIFTER PORTAL GEAR WARRANTY PROGRAM

Thank you for purchasing a High Lifter Products Portal Gear Lift. Our Portal Gear Lifts have been engineered to provide superior performance on your ATV/UTV.

LIMITED LIFETIME WARRANTY:

HIGH LIFTER PRODUCTS, INC. warrants to the **ORIGINAL** purchaser of any Portal Gear Kit for a lifetime of protection from the date of purchase against defects in materials or workmanship, subject to the following conditions:

- a) The product must be properly installed according to all installation instructions.
- b) **HIGH LIFTER** is not liable for any incidental or consequential damages to anything other than the Portal Gear Kit covered by this warranty. **HIGH LIFTER** is not liable for any incurred expenses, labor costs to install/remove/reinstall Portal Gear Kit or any OEM or aftermarket components, loss of use of machine, damage to housings or damage to any aftermarket accessory or OEM components.
- c) If the Portal Gear Kit has been disassembled or modified by a third party, the warranty is null and void.
- d) Any Portal Gear Kit damaged in a collision with any object is excluded from this warranty. However, the Portal Gear Kit may be refurbished for a fee upon repair authorization by the owner. Costs will vary depending on the condition of each Portal Gear Kit assembly.
- e) Warranty is non-transferable from the **ORIGINAL** purchaser.
- f) **HIGH LIFTER** reserves the right to inspect the Portal Gear Kit for determining if there were any defects in the installation and to determine the validity of any warranty claim. The warranty process may require the **ORIGINAL** purchaser to provide photographs of the ATV/UTV and its installed Portal Gear Kit.
- g) Items that will not be covered under the warranty are but not limited to: Bearings, Seals, Gaskets, and Wheel Studs. All other components in kit are subject to review by **HIGH LIFTER** to determine reason for failure and if they meet requirements for warranty coverage.
- h) Warranty will be void on products that show; misapplication, improper installation, abuse, lack of proper maintenance, negligence, or alteration from original design.
- i) Any parts used to repair a portal kit must be purchased from **HIGH LIFTER** or warranty will be voided. For safety reasons it is important that the proper fastener grade, thread engagement, and torque specification be followed to prevent parts from failing. See instructions for torque data/specifications.

REFUSED SHIPMENTS/ORDER CANCELLATION:

Refused shipments are subject to a 20% restocking fee plus all associated freight costs. It is our goal to ship all orders in a timely manner. If a customer wishes to cancel an order (provided it is not a special-order product), it is the responsibility of the customer to cancel the order prior to the product being shipped. If a customer cancels an order after product has been shipped, they refused shipment, cancellation, or return will be subject to a 20% restocking fee and any freight charges incurred. For orders outside the United States, any fees associated with customs or duties are non-refundable.

DAMAGED SHIPMENTS:

All claims for damaged shipments must be made within 72 hours of delivery to the point of destination. Any damage to package should be noted with carrier at the time of delivery if possible. We will not be responsible for damage claims made over 72 hours after delivery to the point of destination.

OBTAINING A WARRANTY CLAIM:

All returns for warranty must be pre-approved by calling 1.800.699.0947. After warranty approval has been granted and a Return Merchandise Approval (RMA) number issued, the Portal Gear Kit must be received by **HIGH LIFTER PRODUCTS** within 15 calendar days. The RMA number must be clearly displayed on the return box or the return will be refused. An RMA number does not imply that a replacement or refund will be issued on any product, but only that we will inspect the Portal Gear Kit for warranty claims. For orders outside the United States, any freight or fees associated with customs and duties are the responsibility of the purchaser and are non-refundable. All claims must be accompanied by the sales receipt detailing date and place of purchase, a written explanation of the problem, a phone number, and e-mail address. A copy of this receipt must be included with the Portal Gear Kit submitted for warranty repair or replacement. The purchaser is responsible for any freight charges on all warranty claims, including incoming freight to High Lifter and return freight to the purchaser.

RMA Number # _____

HIGH LIFTER PRODUCTS WARRANTY CLAIM

Name: _____

Product Number: _____

Address: _____

Place of Purchase: _____

Phone Number: _____

Date of Purchase: _____

E-Mail Address: _____

Reason for Return: _____

Reminder – This claim must be accompanied by a copy of the original receipt.

