



780 Professional Drive N. Shreveport, LA 71105 Phone (318)-524-2270 Fax (318)-524-2297
www.highlifter.com

HONDA 500 FOREMAN Installation Instructions

Read before Installation

This product is designed for use on ATVs and/or RUVs to increase ground clearance and fender clearance. Purchasers should be aware that use of this product may increase the frequency of required maintenance, part wear, and will raise the center of gravity on your ATV and/or RUV, increasing risk of roll-over, injury and death on all types of terrain. It is your responsibility to always inform other operators and passengers of this vehicle about the added risks.

High Lifter Products, products are designed to best fit users ATV/RUV under stock conditions. Adding, modifying, or fabricating any OEM or aftermarket parts will void warranty. High Lifter Products, products could interfere with other aftermarket accessories. If the user has aftermarket products on machine, contact High Lifter Products to verify that they will work together. Adding aftermarket suspension components and/or more aggressive tires can cause breakage of other OEM driveline components such as differentials, axles or drive shafts.

We recommend that wider tires and/or wheel spacers be used to achieve a wider stance and to improve stability of the ATV and/or RUV. Riders should be advised that the handling characteristics of a taller ATV and/or RUV are different and require extra care when riding, particularly on side hills or off-camber situations. If you further raise the center of gravity by adding taller tires, heavy loads to racks or seats, or by any other means, the ATV and/or RUV must be operated with even more care, at slower speeds and on relatively flat ground. All turns should be done at a slow speed, even on level ground.

Operation of an ATV and/or RUV with or without modified suspension components, while or shortly after consuming alcohol or drugs, subjects the rider to the risk of serious bodily harm or possible death. This risk is compounded if the rider does not wear an approved helmet and other safety gear. High Lifter urges that all approved safety gear be worn when riding an ATV and/or RUV as a driver or passenger.

By purchasing and installing High Lifter Products, products, user agrees that should damages occur, High Lifter Products will not be held responsible for loss of time, use, labor fees, replacement parts, or freight charges. High Lifter Products will not be held responsible for any direct, indirect, incidental, special, or consequential damages that result from any product purchased from High Lifter Products. The total liability of seller to user for all damages, losses, and causes of action, shall not exceed the total purchase price paid for the product that gives rise to the claim.

Dealers and other Installers

You are responsible for informing your customer and end user of the information contained above and the increased potential hazards of operating an ATV and/or RUV equipped with modified suspension components. If you install any suspension modifying components, it is your responsibility to also install the warning label prominently in view of the driver and in prominent view of the driver and passenger on RUVs and multi-passenger ATVs. They should also be instructed to notify anyone operating the vehicle, as well as any passengers, that said vehicle is modified.

As discussed above, it is critically important that they be instructed in the need for slower speed operation, regardless of terrain, after this lift kit is installed.

This lift kit contains the following parts:

10x55mm Bolts	4	1" x 1 3/4" Hex Head Bolt	4
10x45mm Bolts	2	1/4" Nuts	4
10mm Nuts	6		
Lift Brackets & Spacers	16		

Parts List

A – Qty 2

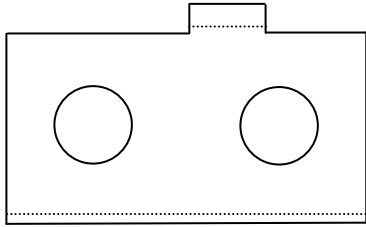

B – QTY 2



C- Qty 2

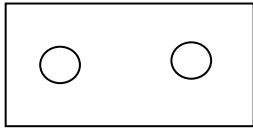

D – Qty 2



E – Qty 2

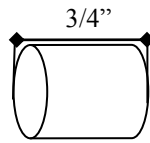

F – Qty 2

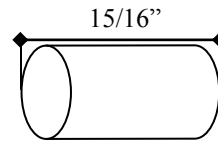

G – Qty 1

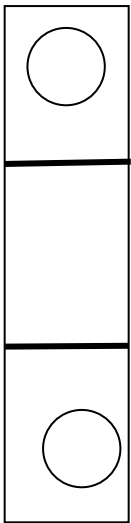

H – Qty 1

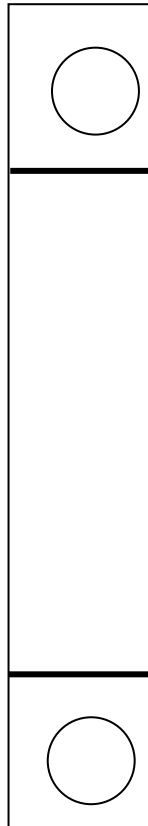

I – Qty 2

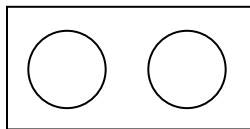

J – Qty 2



10 x 55mm Bolt – Qty 4



1" x 1 3/4" Hex Head – Qty 4



10 x 45mm Bolt - Qty 2



10mm Lock Nut – Qty 6

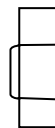

1/4" Lock Nut – Qty 4



Front Lift

- 1) Place jack under center of ATV front end and lift until front wheels clear the ground. Be careful to support ATV properly so that it's secure, but so that the A-arms and shocks can droop to full extension.
- 2) Remove front wheels and shock.
- 3) Place spacer "F" on the inside of the shock mount, place bracket "A", with the notch down and inward over the shock mount. Secure this bracket with a **10x55mm bolt** that is provided with the kit.

Note: The following 2 steps should be read and done at the same time, before action is taken.

Hint: Place 10x55mm bolt through bracket "B" before using the bolt to secure the bottom of the shock eyelet.

- 4) Place bottom of shock inside top of bracket "A", placing spacer "D" between the rear of the shock eyelet and the inside of bracket "A", securing it with a new **10x55mm bolt** from front to back.
- 5) Next, place bracket "B" on bracket "A" (on the front outside of bracket "A") securing it with a new **10mm Nut**.
- 6) Install Bracket "B" on the front of the A-arm and Bracket "C" on the rear of the A-arm, then secure with two $\frac{1}{4}$ " x $1\frac{3}{4}$ " **Hex Head Bolts**. Place a $\frac{1}{4}$ " **Lock Nut** on the U-Bolt. Before tightening all nuts ensure the angle of the shock is at the same original angle.
- 7) Tighten all bolts to manufacturer specifications.
- 8) Repeat this procedure for the other side.
- 9) Install the wheels, torque wheel lugs to manufacturer's specifications, lower and remove jack. Check for clearance problems or misalignment.

Front Installation Diagram

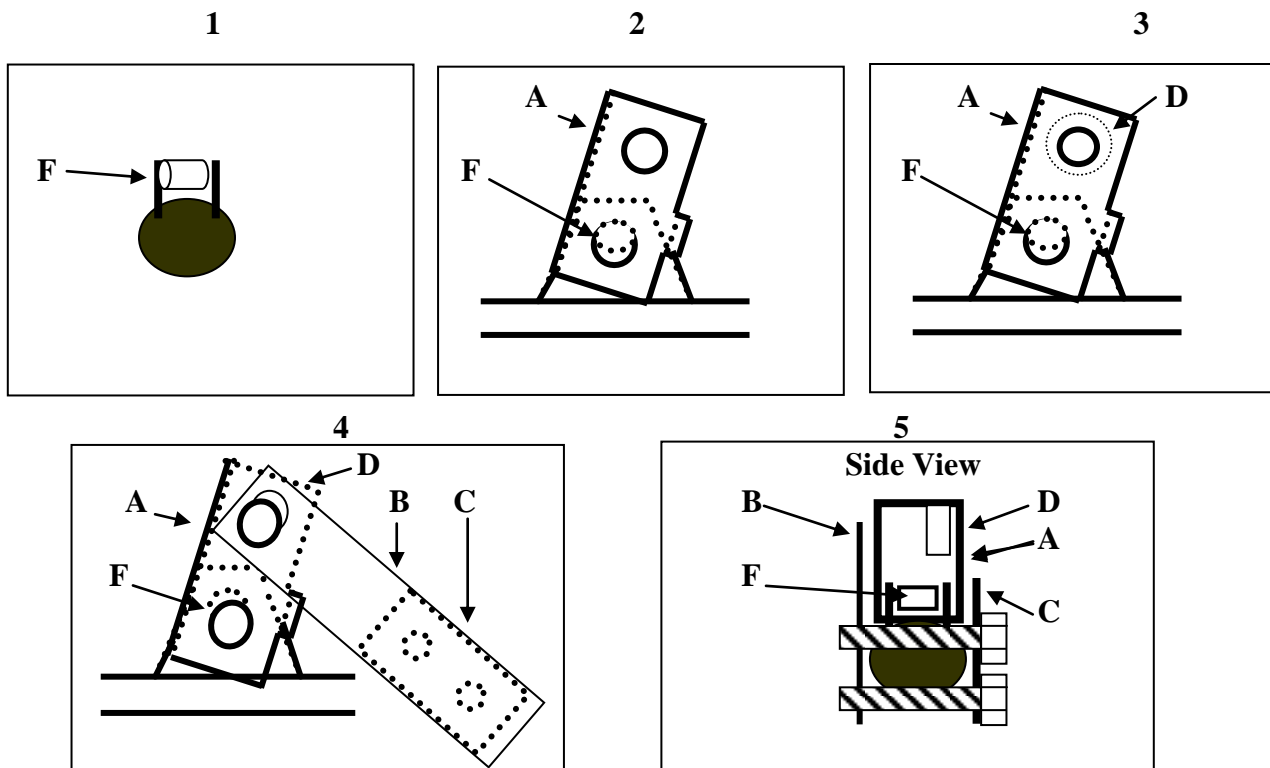

Rear Lift

Left Side

- 1) Place jack under ATV at the rear of the bottom engine skid plate (**not the differential**), and lift until the weight is off of the suspension. Be careful to secure the ATV properly so as not to fall off the jack.
- 2) After removing the bottom of the shocks, jack the ATV up an additional 1"-2".
- 3) Remove the top bolt on the left side of the differential housing, closest to the shock mount.
- 4) Place bracket "J" on the left outside of the shock mount (notch up).
- 5) Place spacer "E" on the inside of the shock mount.
- 6) Place bracket "I" between spacer "E" and the inside of the shock mount, (to the right of spacer "E" and to the left of the inside wall of the shock mount).
- 7) Secure this with the stock OEM bolt.
- 8) Place the bottom of the shock (bottom shock eyelet) between brackets "J" and bracket "I", securing this with a **10x45mm Bolt**. Install bolt from left to right.
- 9) Place end of bracket "G" to the right and outside of bracket "I" securing it with a **10mm Nut**.
- 10) Last, secure the end of bracket "G" to the differential housing, use the OEM nut.
- 11) **DO NOT TIGHTEN NUTS AND BOLTS AT THIS TIME. TIGHTEN AFTER COMPLETION OF RIGHT SIDE.**

Left Rear Installation Diagram

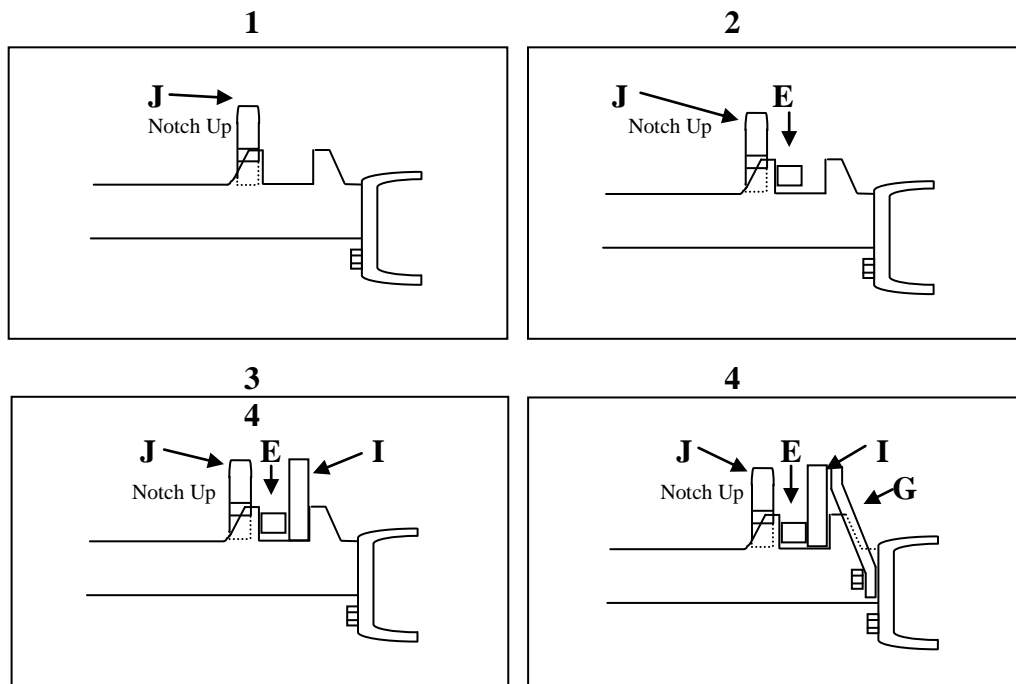

Right Side

- 1) Place bracket “J” on the right outside of the shock mount (notch up).
- 2) Place spacer “E” on the inside of the shock mount.
- 3) Place bracket “I” between spacer “E” and the inside of the shock mount, (to the left of spacer “E” and to the right of the inside wall of the shock mount).
- 4) Secure this with the stock OEM bolt.
- 5) Place bottom of shock (bottom shock eyelet) between brackets “J” and bracket “I”, securing this with a **10x45mm Bolt**. Install bolt from right to left.
- 6) Place end of bracket “H” to the differential housing using the OEM bolt.
- 7) **Tighten all bolts to manufacturer’s torque specifications, on BOTH THE LEFT AND RIGHT SHOCK MOUNT!**

Both Sides

- Tighten all bolts to manufacturer’s torque specifications.
- Lower and remove jack.
- Check for clearance problems or misalignment.

Right Rear Installation Diagram

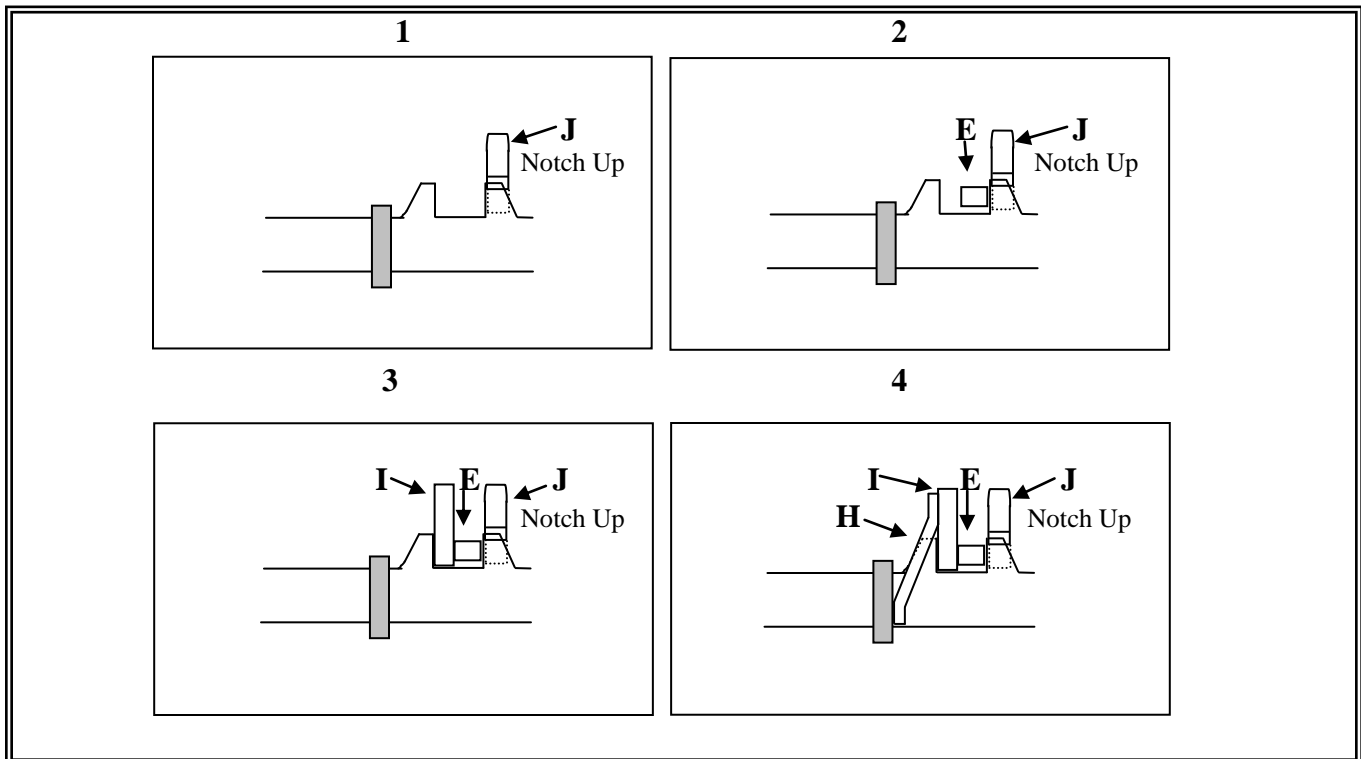

Front Installation Picture

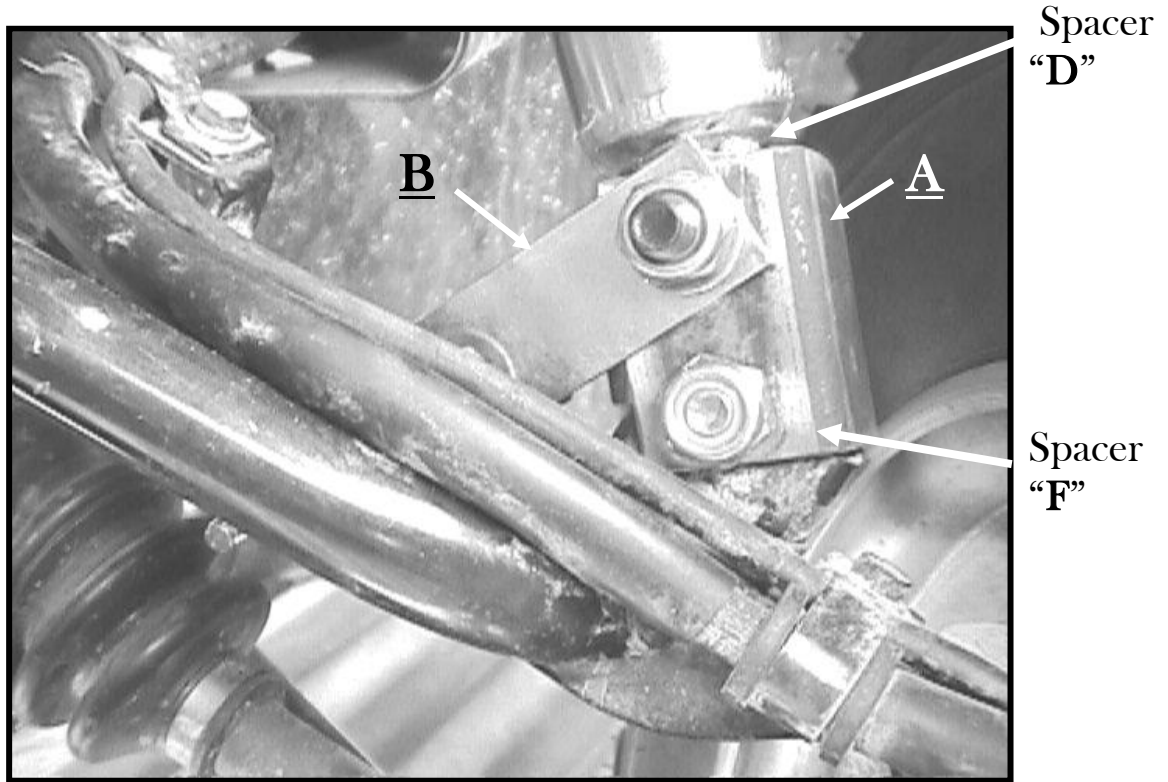

Rear Right Installation Picture

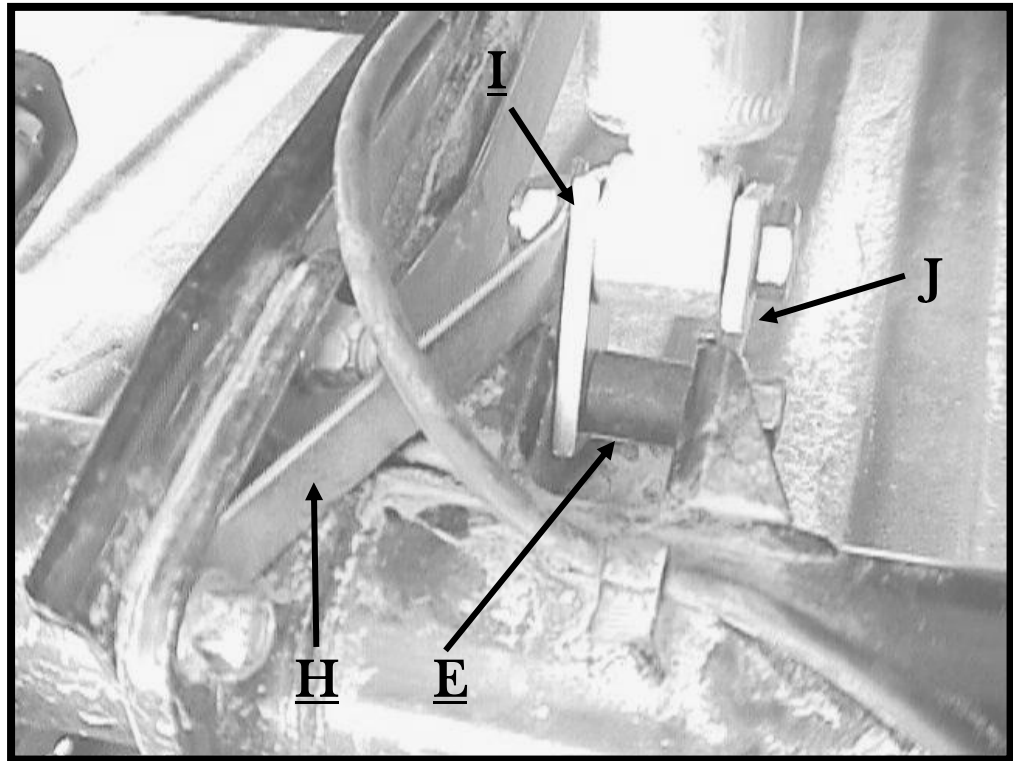

Rear Left Installation Picture

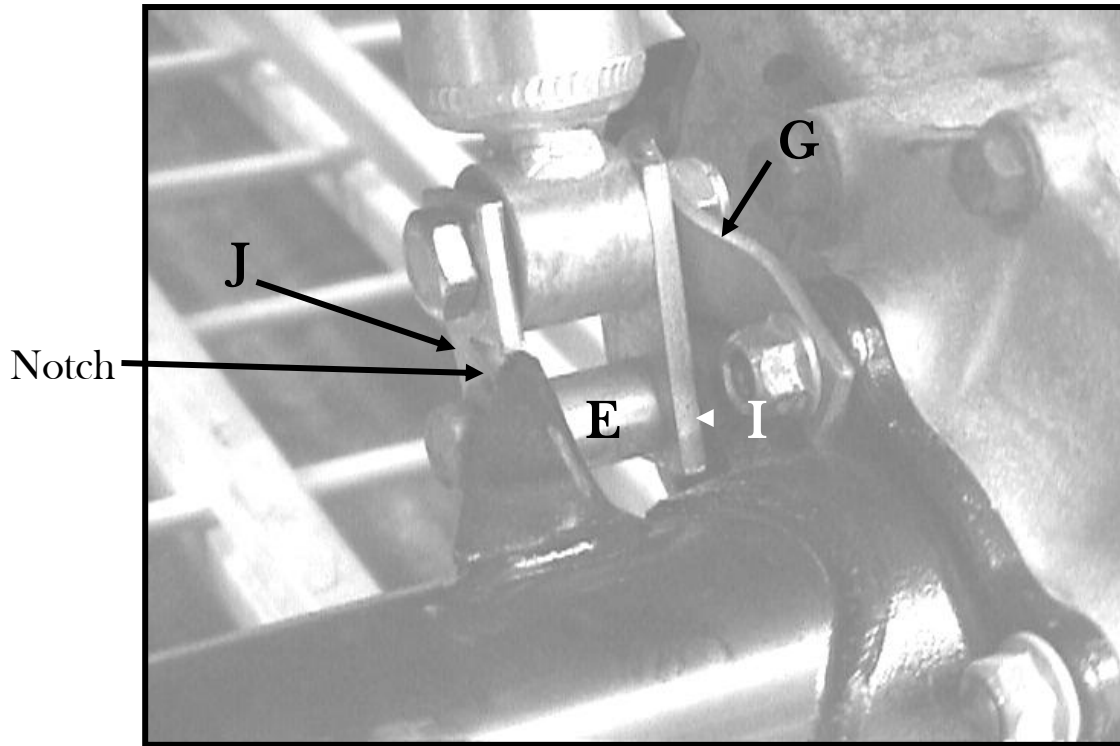

Thank You
For choosing





High Lifter Lifetime Warranty

From the beginning, High Lifter has engineered and manufactured some of the toughest, most durable products on the market. That's why this product comes with a Lifetime Warranty. It's our promise that High Lifter will never let you down.

- The **Lifetime Warranty** covers products sold to the original purchaser only and is not transferable. The term of the warranty is for the lifetime of the vehicle in question.
- Normal wear and tear items and finishes, such as, but not limited to: Heim joints, tie rod ends, ball joints, bearings, seals, bushings, bushing sleeves, zinc plating , powder coating, or chipping and discoloration of any finish is not covered.
- High Lifter will ship the replacement product after the returned product has been inspected by High Lifter staff.
- The warranty shall not include claims for damages, installation time or labor charges, economic losses, inconvenience, transportation, towing, down time, direct or indirect or consequential damages or delay resulting from any defect.
- The warranty does not apply to products that have been improperly applied or improperly installed.

Making a warranty claim

1. All claims must be accompanied by the part and the original sales receipt or other acceptable proof of purchase from the original owner.
2. All warranties must be accompanied with a Return Merchandise Authorization (RMA) number. (Contact High Lifter at 318-524-2270 or 800-699-0947 for an RMA number)
3. When shipping the damaged product:
 - a. Write the RMA number on the outside of the box.
 - b. Also include the RMA number, proof of purchase and any notes inside the box.
 - c. Please keep your tracking number and shipment information.
4. The customer is responsible for shipping the product to High Lifter--return shipping within the lower 48 states will be paid by High Lifter products. With all warranty claims, only standard shipping services apply.
5. High Lifter will process your order within 24 business hours of receiving the returned item.
6. **Ship to:** High Lifter Products, 780 Professional Drive North, Shreveport, Louisiana 71105